

# Technical data sheet

Reduction, PG thread

Item number: 2089041

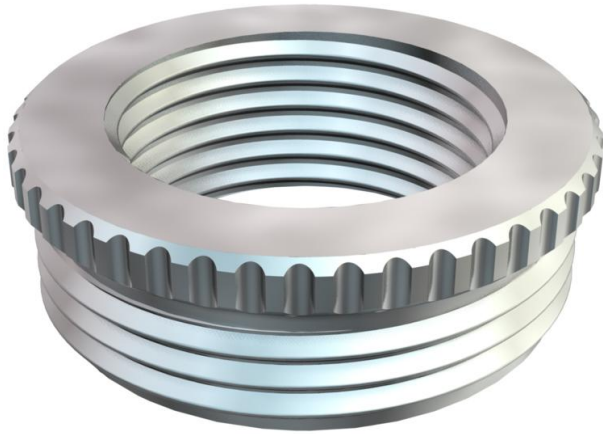

Reduction (Part H) to DIN 46320, with Pg thread to DIN 40430, as a transition from a PG thread hole to a smaller cable gland.

\* Prices according to DEL notation.



**CuZn**  
37 Brass

**N** Nickel-plated

## Master data

Item number	2089041
Type	167 R MS PG11-7
Description 1	Reduction
Manufacturer	OBO
Dimension	PG11-PG7
Material	Brass
Surface	Nickel-plated
Surface standard	
Smallest sales unit	50
Unit of quantity	Piece
Weight	1.03 kg
Weight unit	kg/100 pc.

# Technical data sheet

Reduction, PG thread

Item number: 2089041



## Dimensions

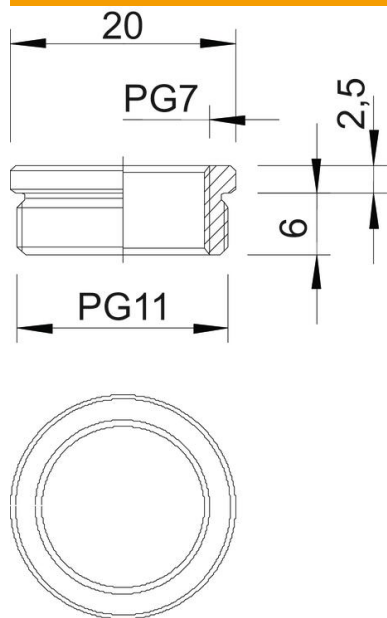

Dimension D	20 mm
Dimension L1	6 mm
Dimension L2	2.5 mm

## Technical data

explosion-proof	no
Thread type: External thread	PG
Thread type: Internal thread	PG
Thread length	6 mm
Thread dimension, PG, external	11
Thread dimension, PG, internal	7
Nickel-plated	yes