

Technical data sheet

Roof conductor holder for tiled roofs, Rd 8

Item number: 5215582



- Conductor holder from stainless steel (V2A)
- Including drill hole in bottom section for quick installation



A2 Stainless steel

Master data

Item number	5215582
Type	157 F-VA 280 35
Description 1	Roof conductor holder
Manufacturer	OBO
Dimension	35 mm
Material	Stainless steel
Smallest sales unit	20
Unit of quantity	Piece
Weight	9.7 kg
Weight unit	kg/100 pc.

Technical data sheet

Roof conductor holder for tiled roofs, Rd 8

Item number: 5215582



Dimensions

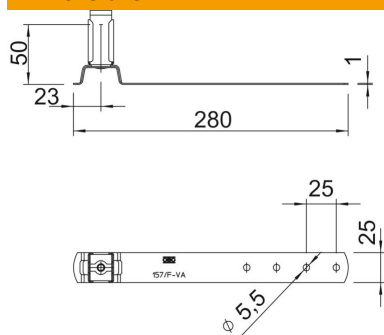

Length	280 mm
Dimension L	280 mm

Technical data

Conductor diameter, max.	8
Conductor diameter, min.	8
Mounting height	50 mm
Fit	Rd 8 mm
Material of the holder	Rustproof steel (V2A)
Material of the support	Rustproof steel (V2A)