

Technical data sheet

Reduction, metric thread

Item number: 2030652



Reduction with metric internal and external thread for mounting plastic cable glands on enclosures. Protection class IP54 without additional connecting seal. Protection class up to IP68 possible with additional connecting seal, e.g. O-ring or flat sealing ring.



PA Polyamide

Master data

Item number	2030652
Type	107 R M40-32 PA
Description 1	Reduction
Manufacturer	OBO
Dimension	M40-M32
Colour	Light grey; RAL 7035
Material	Polyamide
Smallest sales unit	50
Unit of quantity	Piece
Weight	1.4 kg
Weight unit	kg/100 pc.

Technical data sheet

Reduction, metric thread

Item number: 2030652



Dimensions

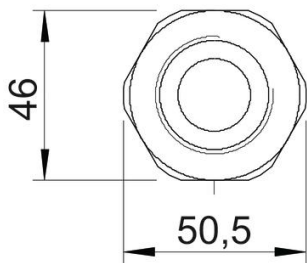
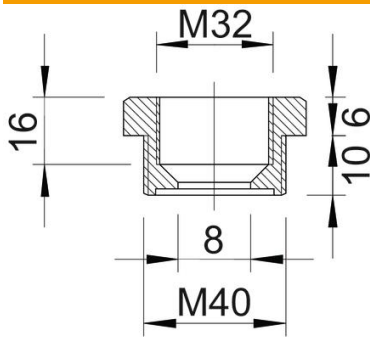

Dimension E	50.5 mm
Dimension L	16 mm
Dimension L1	10 mm
Dimension L2	6 mm
Dimension L3	16 mm

Technical data

explosion-proof	no
Thread type: External thread	Metric
Thread type: Internal thread	Metric
Thread length	10 mm
Thread dimension, metric, external	40
Thread dimension, metric, internal	32
Halogen-free	yes
WAF	46
Nickel-plated	no